

Dialight

Micro LED® SMD LED “598 SERIES” 0606 PACKAGE (1.6mm X 1.6mm X 0.7mm) Bi-Color

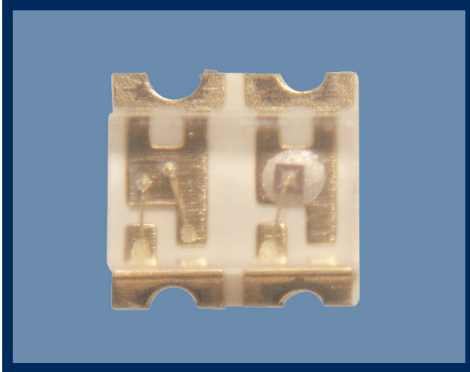

- ### FEATURES / BENEFITS
- ▲ Compatible with automatic placement equipment
 - ▲ RoHS compliant
 - ▲ Packaged in 8mm tape, 7" reel and 20 per strip
 - ▲ Meets EIA-481-1 pkg. std.

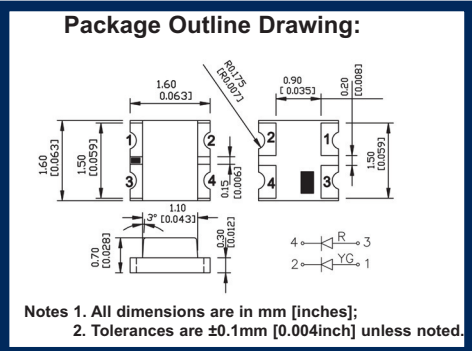

ORDERING INFORMATION

5 9 8 - 8 4 1 0 - 2 0 7 F
Packaging Option

2	20 pieces on tape
7	7" reel 3000pcs / reel

PART NUMBERS

Dialight P/N	EMITTED COLOR	MATERIAL	LENS COLOR	LUMINOUS INTENSITY			DOMINANT WAVELENGTH			FORWARD VOLTAGE			VIEWING ANGLE ° DEGREES	PINOUT
				MIN	TYP	MAX	MIN	TYP	MAX	MIN	TYP	MAX		
598-8410-207F	RED	AllnGaP	Water Clear	40	60	80	630	635	645	1.8	2	2.4	140	4-R, 3, 2-G, 1
	GREEN	AllnGaP	Water Clear	30	40	50	560	565	570	1.8	2	2.4	140	4-R, 3, 2-G, 1
598-8421-207F	RED-ORANGE	AllnGaP	Water Clear	80	100	120	620	625	630	1.8	2	2.4	140	4-R, 3, 2-G, 1
	GREEN	InGaN	Water Clear	200	220	240	520	525	530	2.7	3.2	3.5	140	4-R, 3, 2-G, 1
598-8430-207F	ORANGE	AllnGaP	Water Clear	80	100	150	600	605	610	1.8	2	2.4	140	4-R, 3, 2-G, 1
	GREEN	AllnGaP	Water Clear	30	40	50	562	568	570	1.8	2	2.4	140	4-R, 3, 2-G, 1
598-8440-207F	YELLOW	AllnGaP	Water Clear	120	135	150	587	590	592	1.8	2	2.4	140	4-R, 3, 2-G, 1
	GREEN	AllnGaP	Water Clear	35	50	65	565	570	575	1.8	2	2.4	140	4-R, 3, 2-G, 1
598-8450-207F	YELLOW	AllnGaP	Water Clear	80	120	150	587	590	592	1.8	2	2.4	140	4-R, 3, 2-G, 1
	GREEN	InGaN	Water Clear	90	120	140	525	528	530	2.7	3.2	3.5	140	4-R, 3, 2-G, 1
598-8460-207F	YELLOW	AllnGaP	Water Clear	120	135	150	587	590	592	1.8	2	2.4	140	4-R, 3, 2-G, 1
	RED	AllnGaP	Water Clear	40	50	60	630	640	645	1.8	2.2	2.4	140	4-R, 3, 2-G, 1
598-8470-207F	RED	AllnGaP	Water Clear	20	40	60	627	635	639	1.8	2	2.4	140	SEE EXAMPLE
	YELLOW-GREEN	AllnGaP	Water Clear	20	30	40	565	570	575	1.8	2	2.4	140	SEE EXAMPLE
598-8480-207F	GREEN	InGaN	Water Clear	200	220	240	520	525	530	2.7	3.2	3.5	140	4-R, 3, 2-G, 1
	BLUE	InGaN	Water Clear	60	75	90	470	473	475	2.8	3.2	3.4	140	4-R, 3, 2-G, 1

ABSOLUTE RATINGS (@ Ta = 25°C)

Dialight P/N	Power Dissipation	Forward Current	Reverse Voltage	Operating Temperature Range	Storage Temperature Range	Peak Pulse Forward Current	Electrostatic Discharge
	(mW)	(mA)	(V)	(°C)	(°C)	(mA)	(HBM)
598-8410-207F	48	20	5	-40~+100	-40~+100	100	2000
	48	20	5	-40~+100	-40~+100	100	2000
598-8421-207F	48	20	5	-40~+100	-40~+100	100	2000
	70	20	5	-40~+100	-40~+100	100	2000
598-8430-207F	48	20	5	-40~+100	-40~+100	100	2000
	48	20	5	-40~+100	-40~+100	100	2000
598-8440-207F	72	20	5	-20~+85	-30~+100	100	1000
	72	20	5	-20~+85	-30~+100	100	1000
598-8450-207F	48	20	5	-40~+100	-40~+100	100	2000
	70	20	5	-40~+100	-40~+100	100	2000
598-8460-207F	72	20	5	-20~+85	-30~+100	100	1000
	72	20	5	-20~+85	-30~+100	100	1000
598-8470-207F	48	20	5	-40~+100	-40~+100	100	2000
	48	20	5	-40~+100	-40~+100	100	2000
598-8480-207F	102	20	5	-30~+85	-30~+100	100	1000
	105	20	5	-30~+85	-30~+100	100	1000



A4703



ISO 9001



Dialight Corporation

1501 Route 34 South • Farmingdale, NJ 07727 USA

Tel: (1) 732-919-3119 • Fax: (1) 732-751-5778 • www.dialight.com



MDEI5980606BI_A

MECHANICAL DIMENSIONS

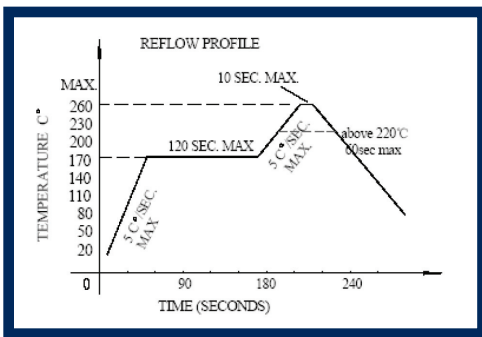
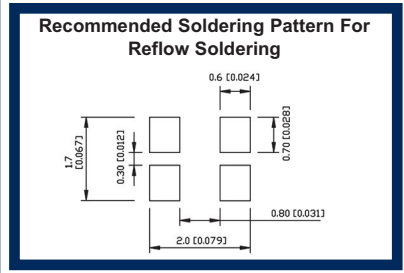
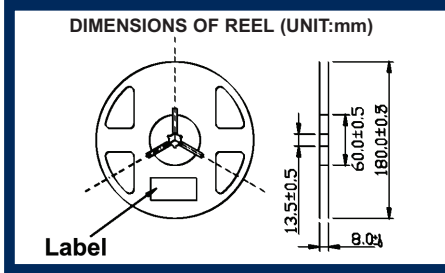
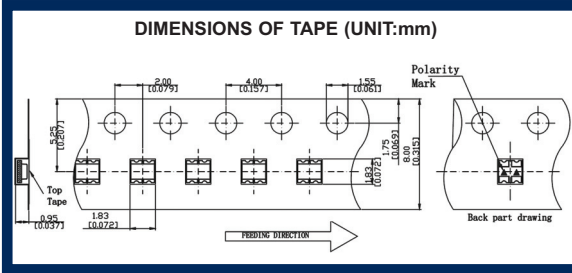

REFLOW SOLDERING		HAND SOLDERING	
Pre-heat	160~180°C	Temperature	300°C Max.
Pre-heat time	120 seconds Max.	Soldering time	3 second Max (one time only)
Peak temperature	260°C Max.	Soldering time	3 second Max (one time only)
Soldering time	10 seconds Max.	Condition	Refer to temperature -profile

OPTICAL AND ELECTRICAL CHARACTERISTICS CURVES

RED 630-642NM, RED-ORANGE 620-630NM, ORANGE 600-610NM, YELLOW 590-595NM, YELLOW 583-590NM, YELLOW GREEN 570-575NM, GREEN 562-570NM

FORWARD VOLTAGE VS FORWARD CURRENT (Ta=25°C)

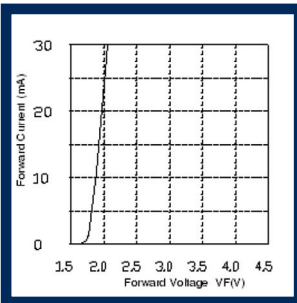

RELATIVE INTENSITY VS FORWARD CURRENT (Ta=25°C)

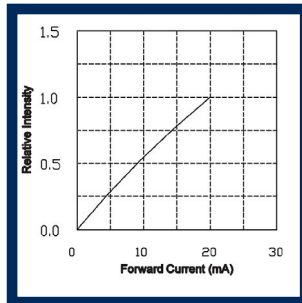

DERATING

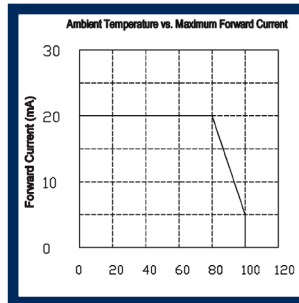

RELATIVE INTENSITY VS AMBIENT TEMPERATURE

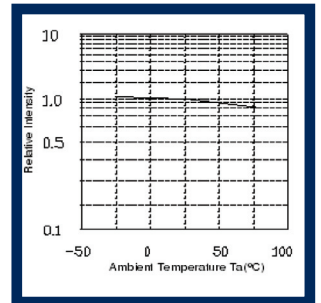

GREEN 520-525NM, BLUE 470-475NM

FORWARD VOLTAGE VS FORWARD CURRENT (Ta=25°C)

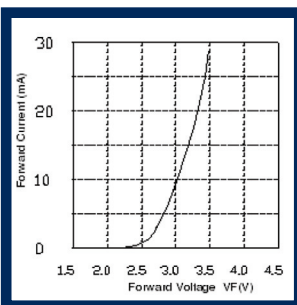

RELATIVE INTENSITY VS FORWARD CURRENT (Ta=25°C)

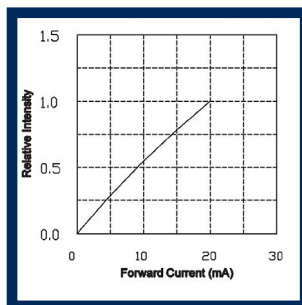

DERATING

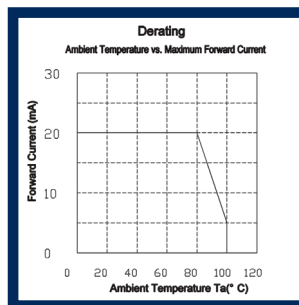

RELATIVE INTENSITY VS AMBIENT TEMPERATURE

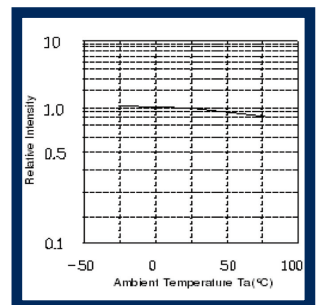

A4703



ISO 9001

Dialight Corporation



Dialight Corporation

1501 Route 34 South • Farmingdale, NJ 07727 USA

Tel: (1) 732-919-3119 • Fax: (1) 732-751-5778 • www.dialight.com



MDEI5980606BI_A